

CORE SETS

Effective core parameters

SYMBOL	PARAMETER	VALUE	UNIT
$\Sigma (1/A)$	core factor (C_1)	1.10	mm^{-1}
V_e	effective volume	3755.1	mm^3
l_e	effective length	64.3	mm
A_e	effective area	58.4	mm^2
A_{\min}	minimum area	50.2	mm^2
W_t	mass of core set	≈ 24.3	g

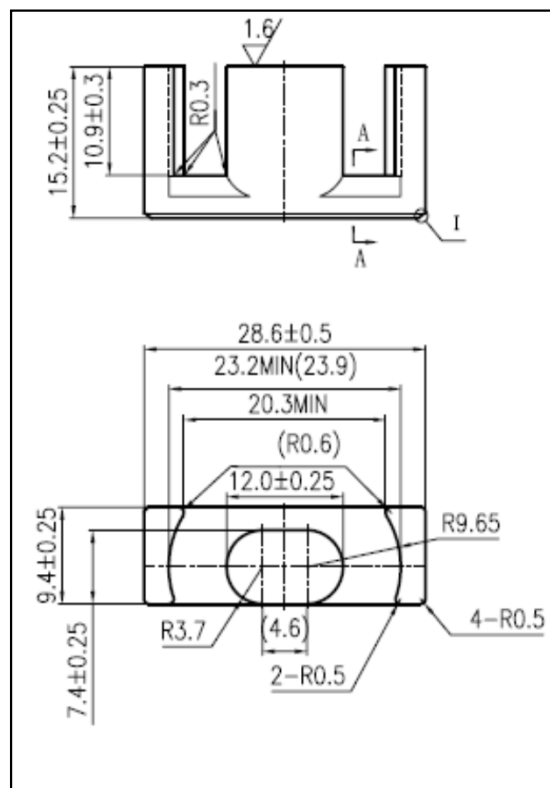

Characteristic

GRADE	AL (nH/N ²)	B (mT)	CORE LOSS (W)
	f=10kHz U=0.25V	H=250A/m f=25kHz T=100°C	f=100kHz B=200mT T=100°C
DMR40	2480±25%	≥315	≤3.04
DMR44	2480±25%	≥315	≤2.68