

CORE SETS

Effective core parameters

SYMBOL	PARAMETER	VALUE	UNIT
$\Sigma (1/A)$	core factor (C_1)	0.82	mm^{-1}
V_e	effective volume	8473.4	mm^3
l_e	effective length	83.4	mm
A_e	effective area	101.6	mm^2
A_{\min}	minimum area	91.9	mm^2
W_t	mass of core set	≈ 46.0	g

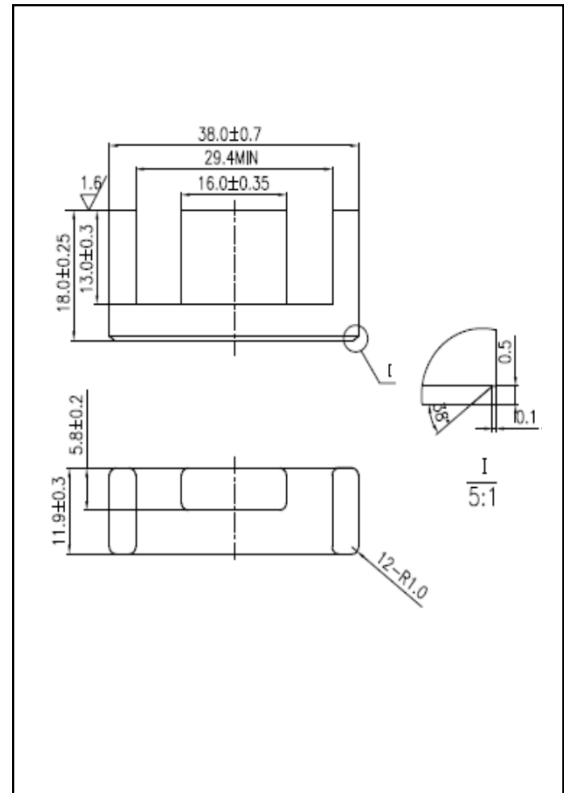

Characteristic

GRADE	AL (nH/N ²)	B (mT)	CORE LOSS (W)
	f=10kHz U=0.25V	H=250A/m f=25kHz T=100°C	f=100kHz B=200mT T=100°C
DMR40	3040 ± 25%	≥ 315	≤ 6.00
DMR44	3040 ± 25%	≥ 315	≤ 5.06