

CORE SETS

Effective core parameters

SYMBOL	PARAMETER	VALUE	UNIT
$\Sigma (1/A)$	core factor (C_1)	0.90	mm^{-1}
V_e	effective volume	11386.12	mm^3
l_e	effective length	101.30	mm
A_e	effective area	112.40	mm^2
A_{\min}	minimum area	96.60	mm^2
W_t	mass of core set	≈ 60.5	g

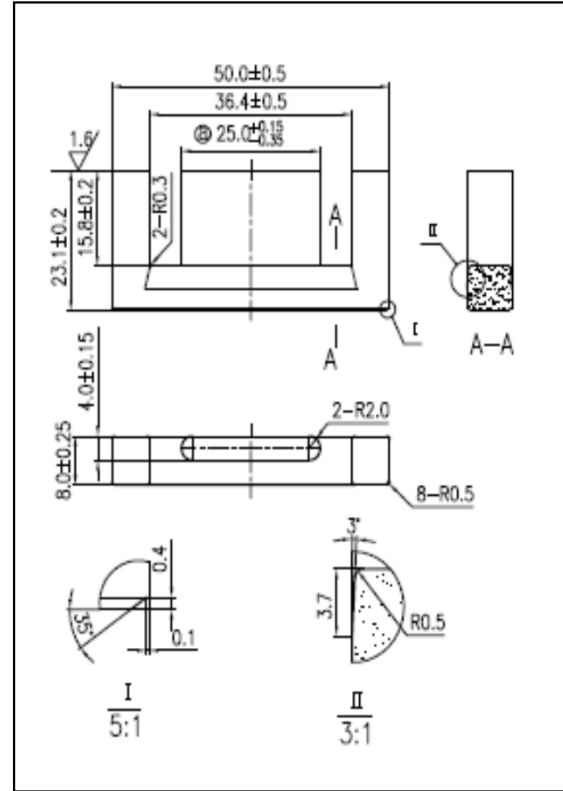

Characteristic

GRADE	AL (nH/N^2)	B (mT)	CORE LOSS (W)
	$f=10\text{kHz}$ $U=0.25\text{V}$	$H=250\text{A/m}$ $f=25\text{kHz}$ $T=100^\circ\text{C}$	$f=100\text{kHz}$ $B=200\text{mT}$ $T=100^\circ\text{C}$
DMR40	$2500 \pm 25\%$	≥ 315	≤ 7.87
DMR44	$2500 \pm 25\%$	≥ 315	≤ 6.66